



X + 0 + Y² 0M^{HZ}

OWNER'S GUIDE

PRODUCT LINE:

Simply Cinema

MODEL NUMBER: **SCS178 (230V)**

DESIGN GOAL: Bring the thrill of live performance and movie sound to the home environment by calling on JBL's professional engineering leadership.

SATELLITE TYPE: Titanium-laminate-dome tweeter, reflex-loaded enclosure

SUBWOOFER TYPE: Bass-reflex enclosure

PORT DESIGN: FreeFlow™ flared

PROFESSIONAL REFERENCE: Cinema Loudspeaker Series

JBL

READ THIS! Important Safety Precautions!

CAUTION

RISK OF ELECTRIC SHOCK DO NOT OPEN

CAUTION: To prevent electric shock, do not remove the grounding plug on the power cord, or use any plug or extension cord that does not have a grounding plug provided.

Make certain that the AC outlet is properly grounded. Do not use an adapter plug with this product.

The lightning flash with arrowhead symbol, within an equilateral triangle, is intended to alert the user to the presence of unshielded "dangerous voltage" within the product's enclosure that may be of sufficient magnitude to constitute a risk of electric shock to persons.



The exclamation point within an equilateral triangle is intended to alert the user to the presence of important operating and maintenance (servicing) instructions in the literature accompanying the appliance.



General:

1. Unpacking: Check the product carefully. If it has been damaged in transit, report the damage immediately by calling your dealer and/or the shipping company that delivered it.

2. Connections: Whenever changing, connecting or disconnecting signal or power cables etc., always turn off all equipment. This prevents transients from entering the equipment and prevents electrical energy from reaching you. Keep all connections out of the reach of children. Before moving the unit, be certain to disconnect any interconnection cords with other components, and make certain that you disconnect any powered units from the AC outlet.

3. Read Instructions. All the safety and operating instructions should be read before the product is operated.

4. Retain Instructions. The safety and operating instructions should be retained for future reference.

5. Heed Warnings. All warnings on the product and in the operating instructions should be adhered to.

6. Follow Instructions. All operating and use instructions should be followed.

7. Water and Moisture. The product should not be used near water—for example, near a bathtub, washbowl, kitchen sink, laundry tub, in a wet basement, or near a swimming pool, and the like.

8. Accessories. To ensure proper operation and to avoid the potential for safety hazards, place the unit on a firm and level surface. When placing the unit on a shelf, be certain that the shelf and any mounting hardware can support the product's weight. Do not place this product on an unstable cart, stand, tripod, bracket, or table. The product may fall, causing serious injury to a child or adult, and serious damage to the product. Use only with a cart, stand, tripod, bracket, or table recommended by the manufacturer, or sold with the product. Any mounting of the product should follow the manufacturer's instructions, and should use a mounting accessory recommended by the manufacturer.

9. Wall or Ceiling Mounting. The product should be mounted on a wall or ceiling only when and as recommended by the manufacturer.

10. Cleaning. Unplug this product from the wall outlet before cleaning. Do not use liquid cleaners or aerosol cleaners. Use a damp cloth for cleaning.

11. Attachments. Do not use attachments not recommended by the product manufacturer, as they may cause hazards.

12. Replacement Parts. When replacement parts are required, be sure the service technician has used replacement parts specified by the manufacturer or that have the same characteristics as the original part. Unauthorized substitutions may result in fire, electric shock or other hazards.

13. Safety Check. Upon completion of any service or repairs to this product, ask the service technician to perform safety checks to determine that the product is in proper operating condition.

14. Feet/Spikes. When positioning, or moving this product ensure that is lifted rather than dragged across any floor/mounting surface. This will avoid any damage to the floor-/mounting surface. Attention! Products and/or product feet constructed of rubber or plastics may, in seldom cases, react chemically and discolor treated or non-treated wooden surfaces if positioned without protection.

15. Warranty: The following conditions may result in a void product warranty:

- the manufacturer's serial number is removed or forged.
- if repairs and/or modifications and/or other treatments/tunings have been carried out by non-authorized personnel or accessories/supplements are attached, which are not approved by manufacturer/importer.

16. Warranty: The following items are not covered by the product warranty:

- Damage caused by inappropriate handling despite clear instructions provided in the owners manual.
- Damage to mechanical parts (such as record-/playback heads, moving rubber and plastic parts and fuses) as well as results of normal wear and tear.
- Damage caused by external action or influence.
- Damage caused by miss-use by user.
- Damage caused by excessive electrical mains supply voltage or lightning strike.
- Damage caused by fire, water or smoke.
- Damage known to buyer prior to purchase.
- Damage caused by professional employment of home entertainment products (e.g. for catering trade, restaurants, public address or infinite loop announcement use etc.)

17. Specifications: All product specifications/features are subject to change without notification.

Passive Products:

18. Amplifiers: Amplifiers used to drive these units must deliver a sufficient output power. A lack of output power may lead to amplifier-clipping, which causes damage not covered by guarantee.

Active (Powered) Products:

19. Ventilation. Slots and openings in the cabinet are provided for ventilation and to ensure reliable operation of the product and to protect it from overheating, and these openings must not be blocked or covered. The openings should never be blocked by placing the product on a bed, sofa, rug, or other similar surface. This product should not be placed in a built-in installation such as a bookcase or rack unless proper ventilation is provided or the manufacturer's instructions have been adhered to.

Make certain that the proper space (more than 10cm) is provided both above and below the unit for ventilation. If the amplifier will be installed in a cabinet or other enclosed area, make certain that there is sufficient air movement within the cabinet, with means provided for hot air to exit and for cool air to be brought in.

Do not obstruct the ventilation slots on the top of the unit or place objects directly over them. Remember, power amplifiers generate heat, and the heatsink fins and ventilation slots that form part of the cabinet are specially designed to remove this heat. Placing other electronic equipment near these heat-dissipation systems may possibly affect the long term reliability of both your amplifier and the objects placed above it.

Do not place CDs, record jackets, owner's manuals or other paper on top of or beneath the unit or in between products containing amplifiers in a stack. This will block the air flow, causing degraded performance and a possible fire hazard.

20. Power Sources. This product should be operated only from the type of power source indicated on the marking label. If you are not sure of the type of power supply to your home, consult your product dealer or local power company. For products intended to operate from battery power, or other sources, refer to the operating instructions.

21. Grounding or Polarization. This product may be equipped with a polarized alternating-current line plug (a plug having one blade wider than the other). This plug will fit into the power outlet only one way. This is a safety feature. If you are unable to insert the plug fully into the outlet, try reversing the plug. If the plug should still fail to fit, contact your electrician to replace your obsolete outlet. Do not defeat the safety purpose of the polarized plug.

22. Power-Cord Protection. Power-supply cords should be routed so that they are not likely to be walked on or pinched by items placed upon or against them, paying particular attention to cords at plugs, convenience receptacles, and the point where they exit from the product. To avoid safety hazards, use only the power cord supplied with your unit. If a replacement cord is used, make certain that it is of a similar gauge. We do not recommend using extension cords with this product. As with all electrical devices, do not run power cords under rugs or carpets or place heavy objects on power cords. Damaged power cords should be replaced immediately, by a qualified service technician, with cords meeting factory specifications. When disconnecting the power cord from an AC outlet, always pull the plug; never pull the cord.

23. Non-use Periods. The power cord of the product should be unplugged from the outlet when left unused for long periods of time.

24. Lightning. For added protection for this product during a lightning storm, or when it is left unattended and unused for long periods of time, unplug it from the wall outlet and disconnect the antenna or cable system. This will prevent damage to the product due to lightning and power-line surges.

25. Overloading. Do not overload wall outlets, extension cords, or integral convenience receptacles, as this can result in a risk of fire or electric shock.

26. Damage Requiring Service. Unplug this product from the wall outlet and refer servicing to qualified service personnel under the following conditions:

- The power-supply cord or the plug has been damaged; or
- Objects have fallen, or liquid has been spilled into, the product; or
- The product has been exposed to rain or water; or
- The product does not operate normally when following the operating instructions. Adjust only those controls that are covered by the operating instructions, as an improper adjustment of other controls may result in damage and will often require extensive work by a qualified technician to restore the product to its normal operation; or
- The product has been dropped, or the enclosure damaged; or
- The product does not appear to operate normally or exhibits a marked change in performance.

27. Servicing. Do not attempt to service this product yourself, as opening or removing covers may expose you to dangerous voltage or other hazards. Refer all servicing to qualified service personnel.

28. Object and Liquid Entry. Never push objects of any kind into this product through openings, as they may touch dangerous voltage points or short-out parts that could result in a fire or electric shock. Never spill liquid of any kind on the product. The apparatus shall not be exposed to dripping or splashing and no objects filled with liquids, such as vases, shall be placed on the apparatus.

29. Heat. The product should be situated away from heat sources such as radiators, heat registers, stoves or other products (including amplifiers) that produce heat. Avoid installation in extremely hot or cold locations, in an area that is exposed to direct sunlight or near heating equipment. When positioning the product in its final location, make certain that it has adequate ventilation on all sides, as well as on the top and bottom.

THANK YOU FOR CHOOSING JBL

For more than 50 years, JBL has been involved in every aspect of music and film recording and reproduction, from live performances to the recordings you play in your home, car or office.

We're confident that the JBL system you have chosen will provide every note of enjoyment that you expected – and that when you think about purchasing additional audio equipment for your home, car

or office, you will once again choose JBL.

JBL Consumer Products

INCLUDED



Four satellites for left/right front and surrounds.

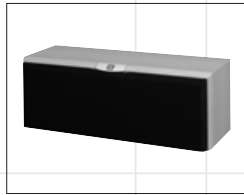

One center channel speaker.



Powered subwoofer.

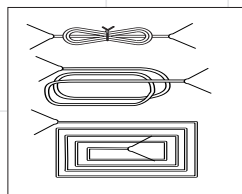

Two 6.1-meter (20-foot) speaker cables for connection from receiver to subwoofer.

Two 4.6-meter (15-foot) speaker cables for connection from subwoofer to front speakers.

Three 12.2-meter (40-foot) speaker cables for connection from receiver to left and right rear satellites and center speaker.

SPEAKER PLACEMENT

Front Speakers

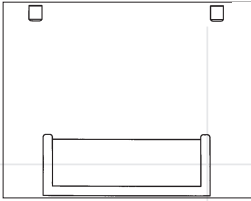

Center Channel Speaker

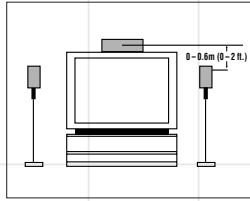

Subwoofer

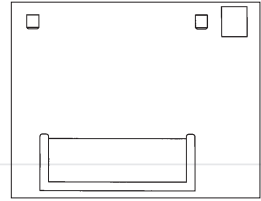

Surround Speakers

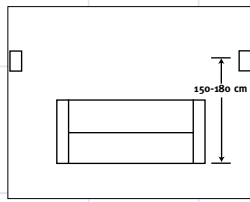
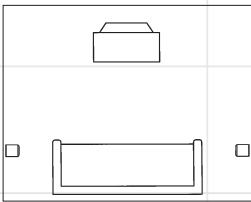

The front speakers should be placed the same distance from each other as they are from the listening position. They should be placed at about the same height from the floor as the listeners' ears will be, or they may be angled toward the listeners.

The center channel speaker should be placed slightly behind the front left and right speakers, and no more than two feet above or below the tweeters of the left and right speakers. It is often convenient to set the center speaker on top of the television set, as shown in the drawing.

The two surround speakers should be placed slightly behind the listening position and, ideally, should face each other and be at a level higher than the listeners' ears. If that is not possible, they may be placed on a wall behind the listening position, facing forward. The surround speakers should not call attention to themselves. Experiment with their placement until you hear a diffuse, ambient sound accompanying the main program material heard in the front speakers.

The low-frequency material reproduced by the subwoofer is mostly omnidirectional, and this speaker may be placed in a convenient location in the

room. However, the best reproduction of bass will be heard when the subwoofer is placed in a corner along the same wall as the front speakers. Experiment with subwoofer placement by temporarily placing the subwoofer in the listening position and moving around the room until the bass reproduction is best. Place the subwoofer in that location.

MOUNTING OPTIONS

Satellites and Surrounds

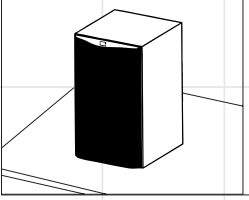

On shelves.

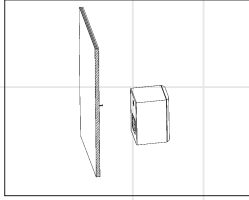

On the wall. Wall brackets are included.

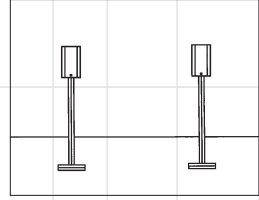

On optional stands.

Wall-Mounting

The customer is responsible for proper selection and use of mounting hardware, available through hardware stores, to properly and safely wall-mount the speakers.

SPEAKER CONNECTIONS

Connection Tips

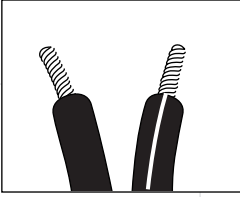

Separate and strip the ends of the speaker wire as shown. Speakers and electronics terminals have corresponding (+) and (-) terminals. Most manufacturers of speakers and electronics, including JBL, use red to denote the (+) terminal and black for the (-) terminal.

The (+) lead of the speaker wire is noted with a stripe. It is important to connect all speakers identically: (+) on the speaker to (+) on the amplifier and (-) on the speaker to (-) on

the amplifier. Wiring “out of phase” results in thin sound, weak bass and a poor stereo image.

With the advent of multichannel surround-sound systems, connecting all of the speakers in your system with the correct polarity remains equally important in order to preserve the proper ambience and directionality of the program material.

Dolby® Pro Logic® (Non-Digital) – Speaker Level

Use this installation method for Dolby Pro Logic applications (not Dolby Digital, DTS® or other digital processing), where the receiver/processor does not have a subwoofer output, or a volume-controlled preamp (line-) level output: Connect your receiver or amplifier's front left and right speaker terminals to the left and right terminals on the subwoofer that are marked "High Level In." Connect the left and right terminals on the subwoofer that are marked "High Level Out." to the corresponding terminals on the back of your front left and right speakers. Connect your receiver or amplifier's center, left and right surround-speaker terminals to the corresponding terminals on the back of your center, left and right surround speakers.

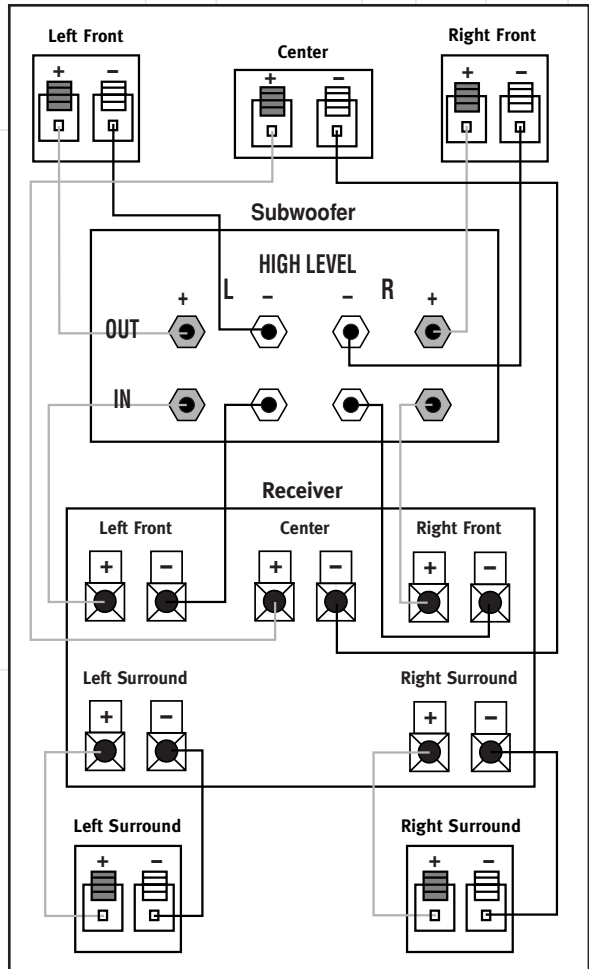

Dolby Pro Logic (Non-Digital) – Line Level

Use this installation method for Dolby Pro Logic applications (not Dolby Digital, DTS® or other digital processing), where the receiver/processor is equipped with a subwoofer output, or a volume-controlled

preamp (line-) level output: Use RCA-type patch cords to connect the line-level subwoofer outputs on your receiver or amplifier to the line-level inputs on the subwoofer. **IMPORTANT:** Do not use the

LFE input on the subwoofer with Dolby Pro Logic processors. Note: If your receiver or amplifier only has one subwoofer output jack, then you will need to use a Y-connector (not included). Plug the male end of the Y-connector into your receiver or amplifier's subwoofer output jack, and connect each of the two female ends to separate RCA-type patch cords. Finally, plug the RCA-type patch cords into the line-level inputs on the subwoofer. Connect each speaker to the corresponding speaker terminals on your receiver or amplifier.

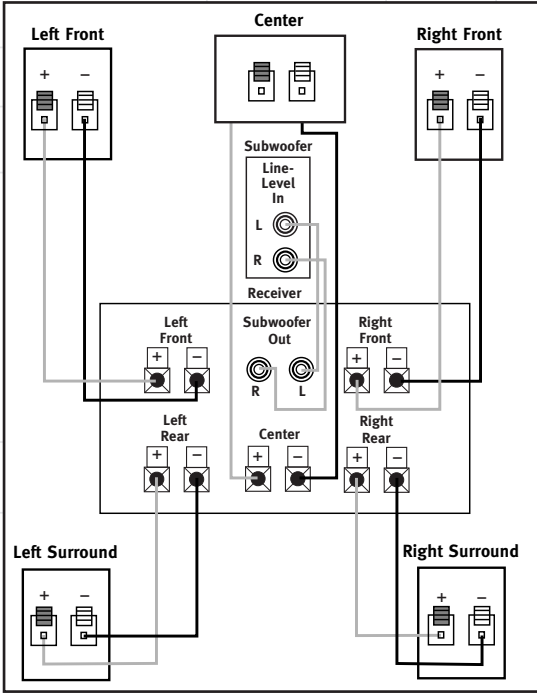

Dolby Digital or DTS® (or Other Digital Surround Mode) Connection

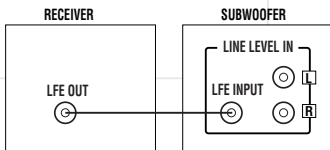

Use this installation method for Dolby Digital, DTS® or other digital surround processors: Use the line-level input jack marked "LFE" for the Low-Frequency Effects channel. Connect this jack to the LFE

output or subwoofer output on your receiver or amplifier. Connect each speaker to the corresponding speaker terminals on your receiver or amplifier.

Make sure that you have configured your surround-sound processor for "Subwoofer On." The front left, front right, center and rear speakers should all be set to "Small."

Note: When using the LFE input, the subwoofer's Crossover control is NOT active, because this function is controlled by your surround processor. When using the LFE input, set the subwoofer's Volume control to "Max" and calibrate the subwoofer level along with the other speakers according to the set-up instructions in the owner's manual for your surround receiver/amplifier.

OPERATION

Press the Master Power Switch (marked Power ①) to the ON position to use the subwoofer. When your receiver or amplifier is off, or is not sending program material to the subwoofer, the subwoofer will be in standby mode. When the subwoofer senses an audio signal, it will automatically turn itself on. If the subwoofer does

not sense a signal after approximately twenty minutes, it will automatically go into standby mode. If you will be away from home for an extended period of time, or if the subwoofer will not be used, switch the Master Power switch ① to the "OFF" position.

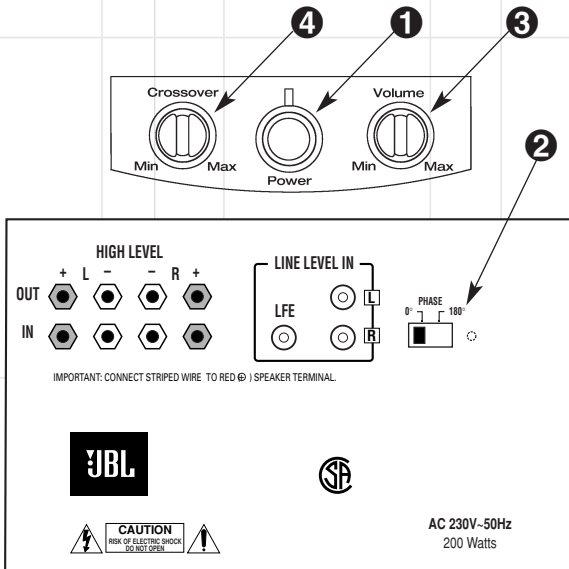

PHASE

The Phase Control ② determines whether the subwoofer's piston-like action moves in and out in phase with the main speakers or opposite the main speakers. This is adjusted by pressing the button to the 0°, or 180° position. The 0° position of the phase button plays the bass signal in phase with the main speakers. The 180° position plays the bass signal 180°, or out of phase with the main speakers. Proper phase adjustment depends on several variables such as subwoofer placement and listener position. Adjust the phase switch to optimize bass output at the listening position.

Every system, room and listener is different. There are no right or wrong settings. This switch offers the added flexibility to adjust your subwoofer for optimum performance for your specific listening conditions without having to move your speakers. If at some time in the future you happen to rearrange your listening room, and move your speakers, you should experiment with the phase switch in both positions, and leave it in the position that optimizes bass performance for your taste.

Volume

Volume can be adjusted using the Subwoofer Volume Control ③, as shown.

Crossover

The crossover filter between the subwoofer and satellites can be adjusted using the Crossover Control ④. The

optimum setting for the SCS178 system is with the Crossover Control ④ set to the "Min" position.

Subwoofer Level

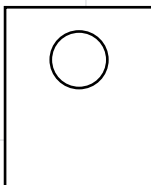
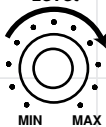

Subwoofer Level

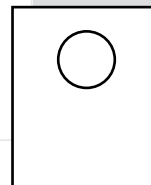
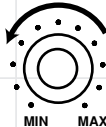

TROUBLESHOOTING

If there is no sound from any of the speakers:

- Check that receiver/amplifier is on and a source is playing.
- Check that the powered subwoofer is plugged in, its Power switch **1** is switched on to the “ON” position.
- Check all wires and connections between receiver/ amplifier and speakers. Make sure all wires are connected. Make sure none of the speaker wires are frayed, cut or punctured.
- Review proper operation of your receiver/amplifier.

If there is no sound coming from one speaker:

- Check the “Balance” control on your receiver/amplifier.
- Check all wires and connections between receiver/ amplifier and speakers. Make sure all wires are connected. Make sure none of the speaker wires are frayed, cut or punctured.
- In Dolby Digital or DTS® modes, make sure that the receiver/processor is configured so that the speaker in question is enabled.

If there is no sound from the center speaker:

- Check all wires and connections between receiver/ amplifier and speaker. Make sure all wires are connected. Make sure none of the speaker wires are frayed, cut or punctured.

- If your receiver/processor is set in Dolby Pro Logic mode, make sure the center speaker is not in phantom mode.
- If your receiver/processor is set in Dolby Digital or DTS® mode, make sure the receiver/processor is configured so that the center speaker is enabled.

If the system plays at low volumes but shuts off as volume is increased:

- Check all wires and connections between receiver/ amplifier and speakers. Make sure all wires are connected. Make sure none of the speaker wires are frayed, cut or punctured.
- If more than one pair of main speakers is being used, check the minimum impedance requirements of your receiver/amplifier.

If there is low (or no) bass output:

- Make sure the connections to the left and right “Speaker Inputs” have the correct polarity (+ and –).
- Make sure the subwoofer is plugged into an active electrical outlet.
- Make sure the powered subwoofer is plugged in and switched on.
- In Dolby Digital or DTS® modes, make sure your receiver/processor is configured so that the subwoofer and LFE output are enabled.

If there is no sound from the surround speakers:

- Check all wires and connections between receiver/ amplifier and speakers. Make sure all wires are connected. Make sure none of the speaker wires are frayed, cut or punctured.
- Review proper operation of your receiver/amplifier and its surround-sound features.
- Make sure the movie or TV show you are watching is recorded in a surround-sound mode. If it is not, check to see if your receiver/ amplifier has other surround modes you may use.
- In Dolby Digital or DTS® modes, make sure your receiver/processor is configured so that the surround speakers are enabled.
- Review the operation of your DVD player and the jacket of your DVD to make sure that the DVD features the desired Dolby Digital or DTS® mode, and that you have properly selected that mode using both the DVD player’s menu and the DVD disc’s menu.

Declaration of Conformity



We, Harman Consumer International
2, route de Tours
72500 Château-du-Loir
France

declare in own responsibility, that the product
described in this owner's manual is in
compliance with technical standards:

- EN 60065:1998
- EN 55013/A14:1999
- EN 55020/A14:1999
- EN 61000-3-2/A14:2000
- EN 61000-3-3/1:1995
- EN 50081-1:1992
- EN 50082-1:1992

A handwritten signature in black ink, appearing to read 'Luc Emmanuel Godard', is written over the list of standards.

Luc Emmanuel Godard
JBL
Harman Consumer International
France, 08/01

SPECIFICATIONS

SCS178 Satellite

Frequency Response (-6dB):	90Hz – 22kHz
Sensitivity (2.83V/1m):	86dB
Nominal Impedance:	4 Ohms
Recommended Amplifier Power	25 – 100 Watts RMS per Channel
Drive Units:	12mm Polyamide/Titanium Laminate Video-shielded HF 100mm Paper Cone Video-shielded Mid/Bass
Dimensions (H x W x D):	235mm x 140mm x 179mm (9.3" x 5.5" x 7")
Weight:	2.8kg (6.2lb)

SCS178 Center

Frequency Response (-6dB):	100Hz – 22kHz
Sensitivity (2.83V/1m):	88dB
Nominal Impedance:	4 Ohms
Recommended Amplifier Power	25 – 100 Watts RMS per Channel
Drive Units:	12mm Polyamide/Titanium Laminate Video-shielded HF Dual 100mm Paper Cone Video-shielded Mid/Bass
Dimensions (H x W x D):	145mm x 402mm x 155mm (5.7" x 15.8" x 6.1")
Weight:	4.5kg (9.9lb)

SCS178 Active Subwoofer

Low Frequency Cut-off:	35Hz
High Frequency Cut-off:	40 Hz - 160Hz Variable
Built-in Power Amplifier:	100 Watts RMS
Drive Unit:	200mm Paper Cone Long Throw Driver. Bass Reflex Enclosure
Dimensions (H x W x D):	450mm x 250mm x 360mm (17.7" x 9.8" x 14.2")
Weight:	13.6kg (30lb)

SCS178 System

Frequency Response (-6dB):	35Hz – 20kHz
----------------------------	--------------

Refinements may be made on occasion to existing products without notice, but will always meet or exceed original specifications unless otherwise stated.

Simply Cinema is a registered trademark of JBL, Incorporated.

* Dolby and Pro Logic are trademarks of Dolby Laboratories.

DTS® is a registered trademark of Digital Theater Systems, Inc.

OWNER'S GUIDE

PRODUCT LINE:

Simply Cinema

MODEL NUMBER: **SCS178 (230V)**

DESIGN GOAL: Bring the thrill of live performance and movie sound to the home environment by calling on JBL's professional engineering leadership.

SATELLITE TYPE: Titanium-laminate-dome tweeter, reflex-loaded enclosure

SUBWOOFER TYPE: Bass-reflex enclosure

PORT DESIGN: FreeFlow™ flared

PROFESSIONAL REFERENCE: Cinema Loudspeaker Series

JBL

**PRO SOUND
COMES HOME™**

JBL Consumer Products
250 Crossways Park Drive, Woodbury, NY 11797
Europe: 2. Route de Tours, 72500 Château du Loir, France

www.jbl.com

©2001 JBL, Incorporated.

JBL is a registered trademark of JBL, Incorporated.

Part No.1111-SCS178

H A Harman International Company